

43426  
43428



Roco

4139 S, B

- 0913N Motor
- 4130S-025 Isolatorgruppe
- 4130S-027 Federnabe
- 4130S-029 Schaltbolzen
- 4130S-031 Schaltkontakt
- 4130S-032 Feder
- 4130S-052 Federkupplung
- 4132S-024 Selen-Diode
- 4132S-039 Stützisolator
- 4132S-047 Lok-Pfeife
- 4134S-040 Stützisolator
- 4134S-085 Pantografplatte
- 4139B-021 Übergangshandgriff
- 4139B-A13 Gehäuse komplett, vorne für 4139B
- 4139B-A14 Gehäuse komplett, Mitte für 4139B
- 4139B-A15 Gehäuse komplett, hinten für 4139B
- 4139S-007 Dach, vorne
- 4139S-008 Stirnfenster
- 4139S-009 Seitenfenster, rechts
- 4139S-010 Seitenfenster links
- 4139S-011 Führerhausfenster
- 4139S-012 Seitenfenster, Mitte
- 4139S-014 Dach, Mitte
- 4139S-018 Grundrahmen, Mitte
- 4139S-022 Dachlaufbrett, vorne
- 4139S-023 Dachlaufbrett, Mitte, lang
- 4139S-024 Dachlaufbrett, Mitte, kurz
- 4139S-026 Luftkessel
- 0913N Motor
- 4130S-025 Insulator group
- 4130S-027 Spring pickup
- 4130S-029 Switch pin
- 4130S-031 Switch contact
- 4130S-032 Spring
- 4130S-052 Spring
- 4132S-024 Diode
- 4132S-039 Insulator
- 4132S-047 Loco whistle
- 4134S-040 Insulator
- 4134S-085 Pantograph plate
- 4139B-021 Handrail
- 4139B-A13 Front cab assembly for 4139B
- 4139B-A14 Middle cab assembly for 4139B
- 4139B-A15 Rear cab assembly for 4139B
- 4139S-007 Roof, in front
- 4139S-008 Front glazing
- 4139S-009 Side glazing, right
- 4139S-010 Side glazing, left
- 4139S-011 Cab glazing
- 4139S-012 Side glazing, in the middle
- 4139S-014 Middle roof
- 4139S-018 Middle frame
- 4139S-022 Roof gangway, front
- 4139S-023 Roof gangway, middle, long
- 4139S-024 Roof gangway, middle, short
- 4139S-026 Air boiler
- 4112S-134 Sechskantansatzschraube, lang
- 4112S-135 Sechskantansatzschraube, kurz
- 4129A-A40 Treibradsatz mit großem Gegengewicht
- 4129S-126 Kupplungseinsatz
- 4134S-031 Zahnrad 19 Z, rechts
- 4134S-095 Schnecke
- 4139B-103 Grundrahmen
- 4139B-129 Leuchtstab, unten
- 4139B-131 Stirnlinse für 4139B
- 4139B-A18 Getriebe komplett für 4139B
- 4139S-003 Grundrahmen für 4139S
- 4139S-004 Getriebekasten, links
- 4139S-005 Getriebekasten, rechts
- 4139S-015 Blindwellenabdeckung
- 4139S-016 Getriebedeckel
- 4139S-025 Einstiegsleiter
- 4139S-029 Lichtleitstab, unten für 4139S
- 4139S-031 Stirnlinse für 4139S
- 4139S-033 Bremszylinder, links
- 4139S-034 Bremszylinder, rechts
- 4139S-058 Radschleifer
- 4139S-300 Treib-Kuppelstange, links
- 4139S-301 Treib-Kuppelstange, rechts
- 4139S-302 Radkontakt
- 4139S-A06 Zurüstsackerl
- 4139S-A21 Schneckensatz
- 4139S-A18 Getriebe komplett für 4139S
- 4139S-A19 Treibradsatz mit Haftring
- 4112S-134 Set screw, long
- 4112S-135 Set screw, short
- 4129A-A40 Wheel set w/large counterweight
- 4129S-126 Standard coupling carrier
- 4134S-031 Gear 19 T, right
- 4134S-095 Worm
- 4139B-103 Main frame
- 4139B-129 Light transmission bar, below
- 4139B-131 Headlight lens for 4139B
- 4139B-A18 Gears assembly for 4139B
- 4139S-003 Main frame for 4139S
- 4139S-004 Gear case, right
- 4139S-005 Gear case, left
- 4139S-015 Blind shaft cover
- 4139S-016 Gear cover
- 4139S-025 Ladder
- 4139S-029 Light transmission bar, below for 4139S

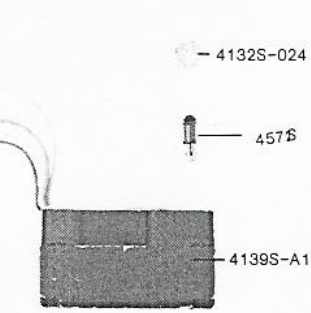
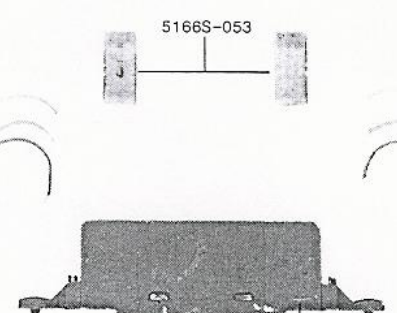
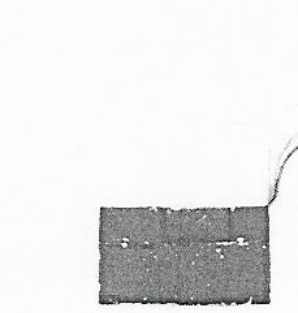
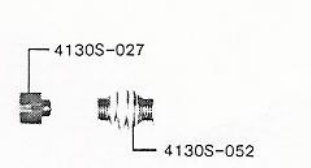
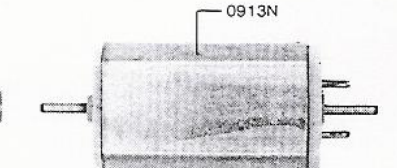
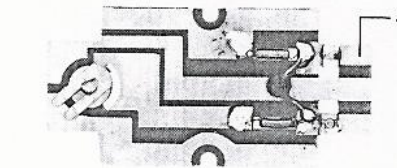
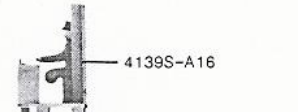
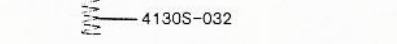
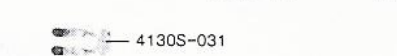
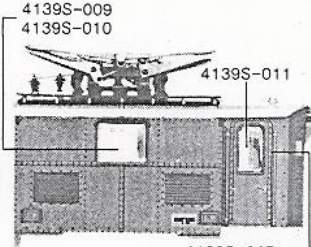
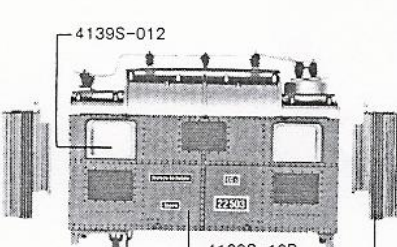
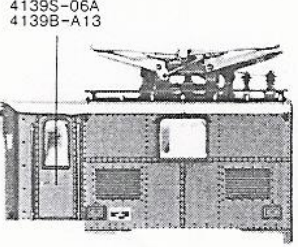
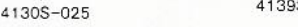
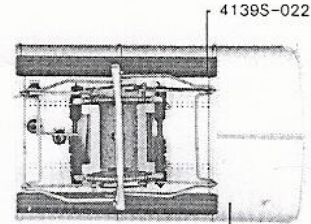
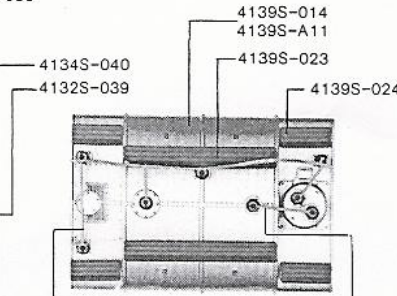
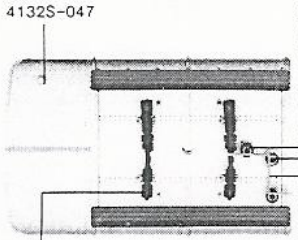
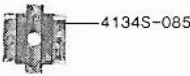

- 4139S-031 Headlight lens for 4139S
- 4139S-033 Brake cylinder, left
- 4139S-034 Brake cylinder, right
- 4139S-058 Wheel contact
- 4139S-300 Connecting rod, left
- 4139S-301 Connecting rod, right
- 4139S-302 Wheel contact
- 4139S-A06 Bag w/accessories
- 4139S-A21 Worm set
- 4139S-A18 Gears assembly for 4139S
- 4139S-A19 Wheel set w/traction tyre







# Roco

## 4139 S, B

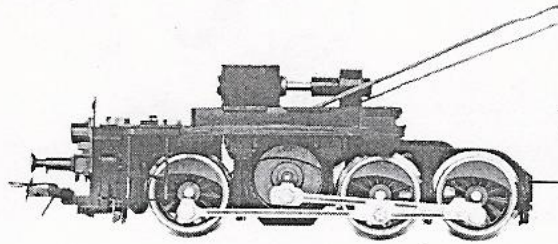

4139S-A18  
4139B-A18



4139S-029  
4139B-129

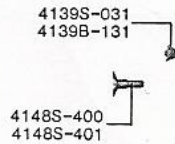

4139S-031  
4139B-131



4139S-003  
4139B-103

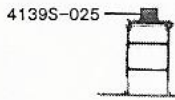
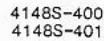

4139S-025



4139S-302

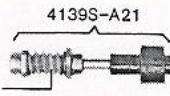

4139S-A21

4134S-095

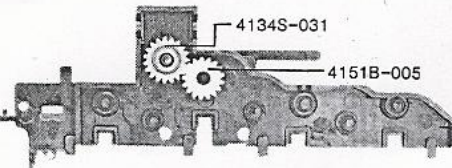

4134S-031

4151B-005

4139S-004  
4139S-005

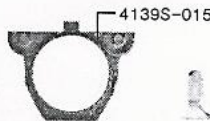

4139S-015

4139S-033  
4139S-034

4139S-058



4129S-126

4456S



4139S-300

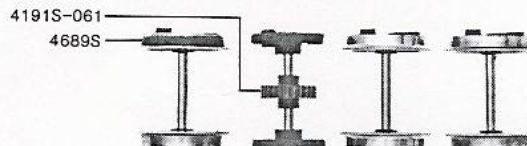

4191S-061  
4689S

4139S-A19

4129A-A40

4139S-A20

4139S-301

4112S-135

4112S-134



4139S-016

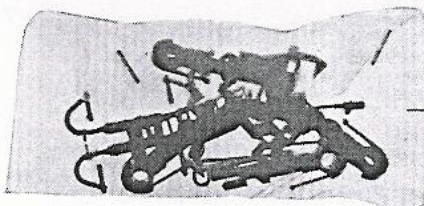

4139S-A06

- 4139S-027 Faltenbalg
- 4139S-030 Leuchstab, oben
- 4139S-032 Führerstand
- 4139S-040 Dachleitung, Mitte, lang
- 4139S-041 Dachleitung, Mitte, kurz
- 4139S-042 Dachleitung, vorne
- 4139S-06A Gehäuse komplett, vorne (1) für 4139S

- 4139S-06B Gehäuse komplett, hinten (2) für 4139S

- 4139S-13B Gehäuse komplett, Mitte für 4139S

- 4139S-A05 Plantine komplett
- 4139S-A11 Dach, Mitte, komplett
- 4139S-A12 Dach, vorne, komplett
- 4139S-A16 Führerstand mit Lokführer
- 4139S-A17 Ballastgewicht komplett

- 4139S-027 Papier-Zwischenlage

- 4487R Pantograf
- 4572S Glühlampe
- 5166S-053 Gummibettung
- M 2 x 6 Schraube
- 2,2 x 6,5 Selbstschneideschraube

- 4139S-027 Concertina wall
- 4139S-030 Light transmission bar, at the top
- 4139S-032 Driver's cab
- 4139S-040 Roof wire, middle, long
- 4139S-041 Roof wire, middle, short
- 4139S-042 Roof wire, front
- 4139S-06A Front (1) cab assembly for 4139S

- 4139S-06B Rear (2) cab assembly for 4139S

- 4139S-13B Middle cab assembly for 4139S

- 4139S-A05 Printed circuit
- 4139S-A11 Middle roof assembly
- 4139S-A12 Front roof assembly
- 4139S-A16 Driver's cab w/driver
- 4139S-A17 Weight assembly

- 4139S-027 Insulating paper
- 4487R Pantograph
- 4572S Light bulb
- 5166S-053 Rubber-embedding
- M 2 x 6 Screw
- 2,2 x 6,5 Screw

- 4139S-A20 Blindwelle
- 4148S-400 Puffer, flach
- 4148S-401 Puffer, gewölbt
- 4151B-005 Zahnrad 17 Z, links
- 4191S-061 Zahnrad 23 Z, rechts
- 4456S Standardkupplung
- 4689S Haftring

- 4139S-A20 Blind shaft
- 4148S-400 Buffer, flat
- 4148S-401 Buffer, vaulted
- 4151B-005 Gear 17 T, left
- 4191S-061 Gear 23 T, right
- 4456S Standard coupling
- 4689S Traction tyre